



# PORTABLE SPEAKER SYSTEM

User's Guide

MODEL:  
CR10



Smart Device  
not included.

- ▶ Portable Speaker System
- ▶ Smart Device Cradle Holder
- ▶ Includes Mini-USB Cable

## Contents

---

Thank you for purchasing our product. For operation and security, read this manual carefully and keep it handy for future reference.

|  |              |
|--|--------------|
| <b>Contents</b> .....                      | <b>01</b>    |
| <b>Features</b> .....                      | <b>01</b>    |
| <b>Warnings and Precautions</b> .....      | <b>02</b>    |
| <b>Important Safety Instructions</b> ..... | <b>03</b>    |
| <b>What's in the Gift Box</b> .....        | <b>04</b>    |
| <b>Location of Functions</b> .....         | <b>05</b>    |
| <b>Operation</b> .....                     | <b>06-08</b> |
| <b>Troubleshooting</b> .....               | <b>09</b>    |

## Features

---

- ▶ Portable Speaker System
- ▶ Smart Device Cradle Holder with Insert to "Cradle" Any and All Types of Smart Devices
- ▶ View Smart Devices Vertically or Horizontally
- ▶ Includes Mini-USB Cable

# Warnings and Precautions

---

**WARNING:** To reduce the risk of fire or electric shock, do not expose this unit to rain or moisture.

**CAUTION:** Use of controls or adjustments or performance of procedures other than those specified may result in hazardous radiation exposure.

“**Caution Marking and Rating Label**” is affixed under the lid or on the bottom of the unit with a mass not exceeding 7kg.



This symbol is intended to alert you to the presence of uninsulated, dangerous voltage within the unit's enclosure that might be of a sufficient magnitude to constitute a risk of electric shock. **DO NOT OPEN THE UNITS CASE.**



This symbol is intended to inform you that important operating and maintenance instructions are included in the literature accompanying this product.

## SAFETY

For units with an insertable AC Power Adapter cordset:

- The power adapter should remain operable for its intended use. Disconnect the AC Power Adapter if you are not intending to use the unit for a long period of time.
- When connecting or disconnecting the AC Power Adapter Cord, grip the plug and not the cord itself. Pulling the cord may cause damage and create a hazard.

For units with a Rechargeable Battery:

- Do not expose batteries to excessive conditions – extreme cold, heat, sun or fire.

## MOISTURE AND CONDENSATION

If the unit is exposed to moisture and extreme cold temperatures and moved to a warm environment, condensation may form on the units internal components. Under these circumstances, turning the power "ON" may cause damage to the unit or cause harm to the user. Allow the unit to stand in a warm environment for 1 to 3 hours and allow the unit to air dry safely.

## WHEN IN USE

- Do not use this unit in conditions that are extreme – hot, cold, dusty or humid.
- Do not restrict the air flow of the unit by placing it on a soft surface like a bed, carpet or covering.

## FCC INFORMATION

This unit complies with part 15 of the "FCC Rules." Operation is subject to the following conditions:

1. This unit may not cause harmful interference.
2. This unit must accept any interference received, including interference that may cause undesirable operation.

# Important Safety Instructions

**1. Read These Instructions:** All safety and operations manual should be read before the product is operated.

**2. Keep These Instructions:** The safety and operations manual should be retained for future reference.

**3. Heed All Warnings:** All warnings applicable to the unit and in the operations manual should be adhered to.

**4. Follow All Instructions:** All operations manual should be followed.

**5. Water and Moisture:** Do not use this unit near water. For example, do not use near a bath tub, wash bowl, kitchen sink, or laundry tub. Do not use this unit in a wet basement or near a swimming pool or similar location. The unit shall not be exposed to dripping or splashing and no objects filled with liquids (ex: vases), shall be placed on or near this unit.

**6. Cleaning:** Clean the unit only with a dry cloth. Unit must be unplugged from the wall outlet before cleaning. Do not use liquid cleaners or aerosol cleaners on the unit.

**7. Ventilation:** Slots and openings in the cabinet of the unit are provided to ensure reliable operation and ventilation and to protect the unit from overheating. The openings must not be covered and should never be blocked by placing the product on a soft surface like a bed, sofa, or rug. This unit should not be placed in a built-in installation like a bookcase or rack, unless proper ventilation is provided.

**8. Heat:** Do not install the unit near any heat source like a radiator, heat register, stove or other device that produces heat, including amplifiers.

**9. Grounding or Polarization:** If applicable, do not disable or circumvent the polarized or grounding-type plug. A polarized plug has 2 blades with 1 wider than the other. A grounding-type plug has 2 blades and a 3" grounding plug. The wide blade, or the 3" prong, is provided for your safety. If the provided plug does not fit into an outlet, consult a qualified electrician for replacement of this outlet.

**10. Power Cord Protection:** Protect the power cord from being walked on, pinched or cut or damaged in any way. If any damage occurs, consult with a trained technician for repair.

**11. Accessories:** Only use accessories specified and approved by the

manufacturer. Do not place this unit on an unstable cart, stand, tripod, bracket or table that has not been previously approved by the manufacturer. This unit may fall, causing serious injury to a child, adult or to the unit itself. Any mounting of the unit should be done within the manufacturer's guidelines.

**12. Transporting:** If a pre-approved device is used to transport this unit, caution and care must be observed and practiced to avoid damages. Make sure the device and unit together are stable before moving.



PORTABLE  
CART  
WARNING

**13. Lightning:** Unplug this unit and disconnect the antenna or cable system during lightning storms or when unused for long periods of time. This will help prevent damage to the unit due to lightning and power line surges.

**14. Servicing:** Do not attempt to service this unit yourself. Opening or removing covers may expose you to dangerous voltage or other hazards. Refer all servicing to a qualified service technician.

**15. Power Sources:** Only connect to the type of household power supply as indicated in the operations manual and "Caution Marking and Rating Label." If you are not sure of the type of power supplied to your home (or location of the outlet the unit is being plugged into), consult with the local power company. For units intended to operate from battery power, or other sources, refer to the manufacturer's operations manual.

**16. Overloading:** Do not overload wall outlets or extension cords. This can result in a risk of fire or electric shock and may be hazardous.

**17. Foreign Material:** Protect this unit from intrusion of any foreign substances like dirt, water, moisture and insects. Do not force any foreign materials or chemicals into this unit. This could result in a risk of fire or electric shock and may be hazardous.

**18. Replacement Parts and Safety Check:** When replacement parts are required, be sure the service technician

has used replacement parts specified and approved by the manufacturer. Ask the service technician to perform safety checks to ensure the proper operation to avoid possible fire, electric shock or other hazards.

**19. Outdoor Antenna Grounding:** If an outside antenna or cable system is connected to the unit, be sure the antenna or cable system is grounded to provide some protection against voltage surges and built-up static charges. If there is any doubt to the proper grounding of these systems, contact a qualified electrician to inspect your location.

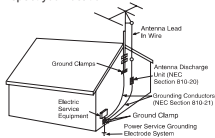

**20. Wall or Ceiling Mounted:** The unit should be mounted to a wall or a ceiling only as recommended by the manufacturer.

**21. Disconnect Device:** Make sure all disconnect devices are in proper working condition and readily available in the event of an emergency or if power "off" is needed quickly.

**22. Protective Attachment Plug:** If applicable, this unit may be equipped with an attachment plug having overload protection. This is a safety feature. See the operations manual for replacement or resetting of this protective device. If replacement of the plug is required, be sure the qualified service technician has used a replacement plug specified by the manufacturer that has the same overload protection as the original plug.

**23. Power Lines:** An outside antenna system should not be located in the vicinity of overhead power lines or other electric light or power circuits, or where it can fall into such power lines or circuits. When installing an outside antenna system, extreme care should be taken to keep from touching such power lines or circuits, as contact with them may be fatal. Always consult with your local power company before installing an outside antenna.

## What's in the Gift Box

---



CR10-Base Unit



Cradle Holder Insert



AUX IN Cable



Mini-USB Cable



User's Manual

## Location of Functions

---

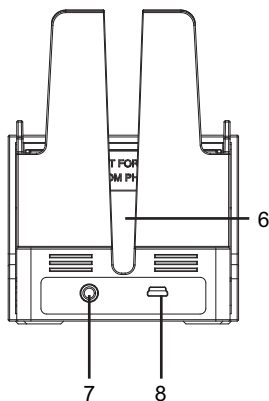
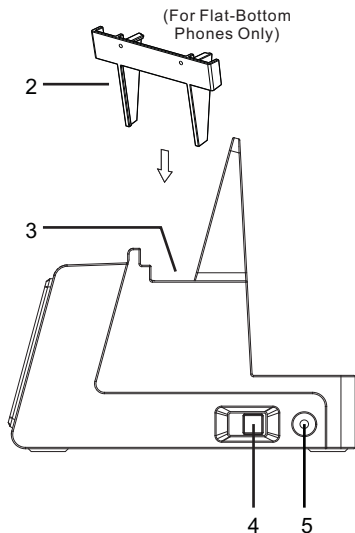
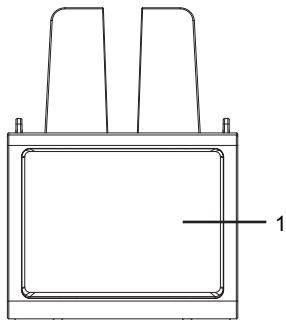



1. Speaker
2. Cradle Holder Insert (For Flat-Bottom Phones Only)
3. Smart Device Holder
4. Power Switch
5. LED Indicator
6. Charging Cord Gap
7. AUX IN Jack
8. Mini-USB Jack

# Operation

## 1. Connect the Unit to An External Power Source:

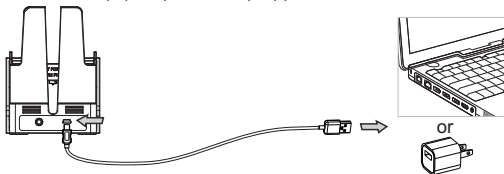
Connect the Mini-USB cable (included) to any external USB Port with an output of DC 5V, 500mA and up (computer or laptop).



- A. Turn the unit "On" with the  button in the "ON" position. The power indicator will light up **RED**.
- B. Turn the unit "Off" with the  button in the "OFF" position. The power indicator will not light up.

## 2. Cradle and Charge Your Smart Device:

- A convenient stand to cradle and hold your Smart Device on your desk, counter or table while connected to any USB Port with output of DC 5V, 500mA and up.
- Setup for **Smart Devices**: The shape of the smart device will determine if an Insert is needed. Use the included insert for flat-bottom phones (a) only. Round-bottom phones (b) do not require the insert.

### Optional Insert

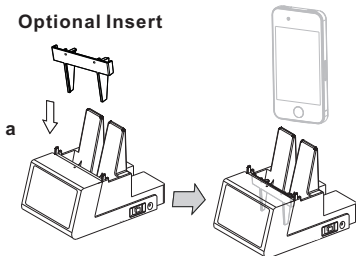

For **FLAT**-bottom phones

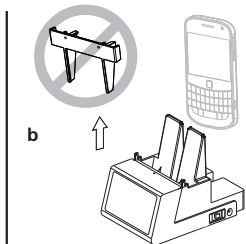

For **ROUND**-bottom phones

## Operation (continued)

---

### A. Setup for **Smart Phones**:

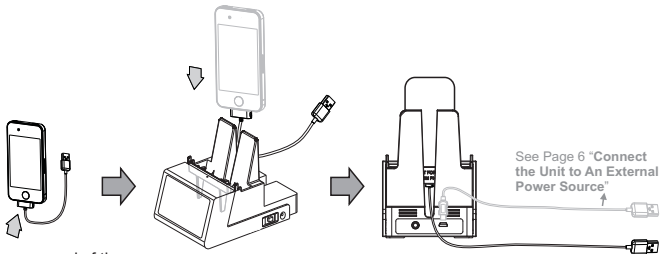

Plug one end of the Charging Cable or adapter (not included) that comes with your smart device into the charging port of the smart device.

Place your smart device into the Cradle of the unit. See "Setup for **Smart Devices**" on page 6.

Plug the other end of the Charging Cable or adapter (not included) that comes with your smart device into an output power that your Smart Device desired.

### B. Setup for **Tablets and MIDs**:

Rest your Smart Device - Vertically or Horizontally.

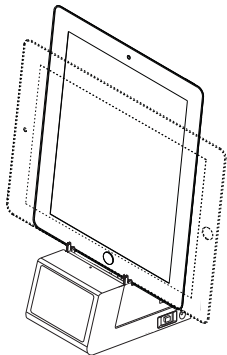



## Operation (continued)

### 3. Using the Auxiliary Input (AUX IN) Jack:

You can play other music sources through the speakers by connecting the **AUX IN Jack** to your external device's Auxiliary Output (AUX OUT) Jack or Headphone Jack. May be used with MP3 or other digital audio players.

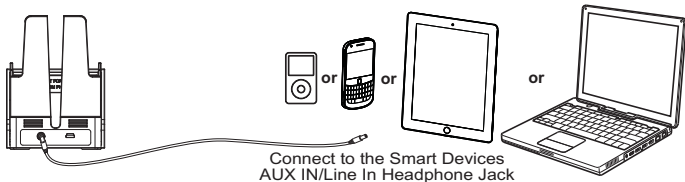

- Turn the unit to the "ON" position.
- Plug one end of an audio cable into the **AUX OUT/Headphone Jack** of your Smart Device and the other end of the audio cable into the Unit's **AUX IN Jack**.

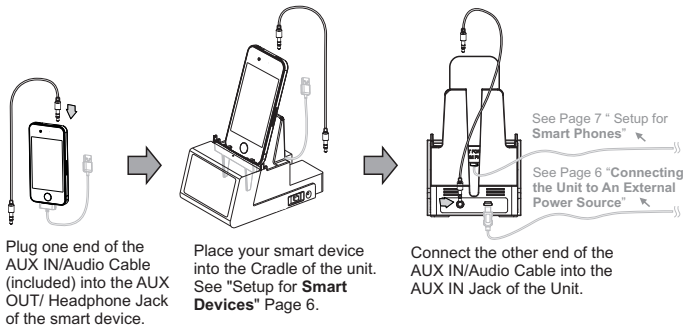

- Use the controls of the external Smart Device to begin playing, adjust volume, stop playing etc..
- Turn the unit to the "OFF" position when finished listening.

| <b>Symptom</b>      | <b>Possible Cause</b>                    | <b>Solution</b>  |
|---------------------|--|--|
| No sound.           | Power cord disconnected or loose.        | Check the connection or the power cord.  |
|                     | AUX IN cable disconnected or loose.      | Check the connection.  |
|                     | Smart Device's system volume is too low. | Increase the system volume.  |
| Sound is distorted. | Volume level is too high.                | Decrease the volume.   |
|                     | Sound source is distorted.               | If the Smart Device's sound source is old or poor quality, distortion and noise are easily noticed with high-power speakers. Try a different audio file from a trusted source. |



# ORDER FORM

## ACCESSORY USB CHARGING CORDS

USB charging cords for pre-Smart Phone generations

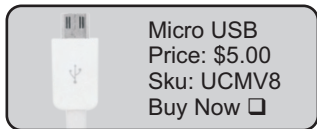
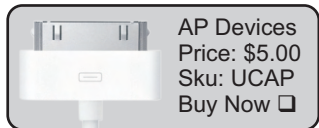

**Make Checks or Money Orders Payable to: DOK Solution, LLC. Add \$3.00 S&H.**

PLEASE PRINT CLEARLY

Name: \_\_\_\_\_

Address: \_\_\_\_\_

City: \_\_\_\_\_ State: \_\_\_\_\_ Zip: \_\_\_\_\_

Phone: \_\_\_\_\_

Email: \_\_\_\_\_

Brand of Phone: \_\_\_\_\_ Model No.: \_\_\_\_\_

Visa  MasterCard  Discover  AMEX

CC# \_\_\_\_\_

Exp Date: \_\_\_\_\_ / \_\_\_\_\_ CVV \_\_\_\_\_ Signature: \_\_\_\_\_