

Dok™

Universal Multi-Charging Station

User's Guide

MODEL:
CR33

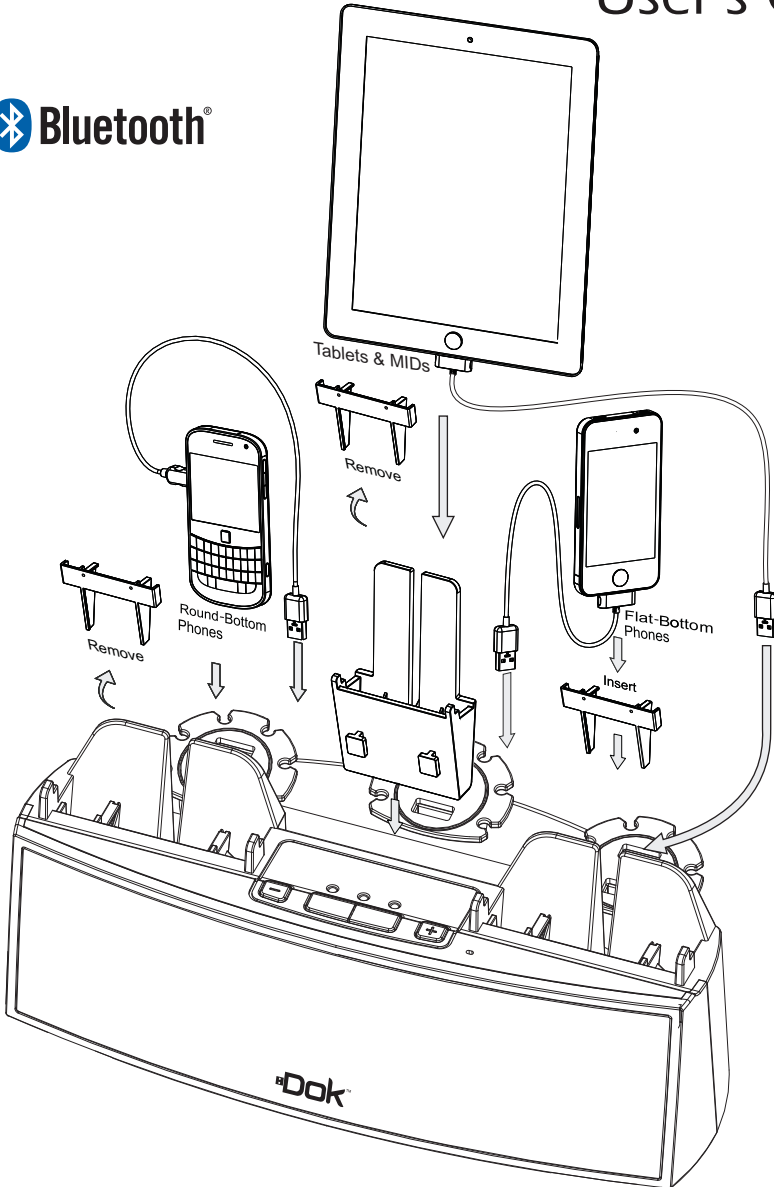

- ▶ Charges 5 Devices and Holds 3 in Cradle Holders
- ▶ SCD (Smart Current Detection) Technology
- ▶ Wirelessly Plays Music and Answers Calls
- ▶ AUX IN for External Device
- ▶ Tidy-Cable Organizer

Contents

Thank you for purchasing our product. For operation and security, read this manual carefully and keep it handy for future reference.

Contents	01
Features	01
Warnings and Precautions	02
Important Safety Instructions	03
Quick Start On Charging Your Device	04-08
What's in the Gift Box	09
Location of Functions	10
Operation	11-14
Troubleshooting	15

Features



MULTI-CHARGER DOCKING STATION

- **Wireless Bluetooth Speaker System**

Hands-Free phone while charging and playing music.

- **SCD Technology**

Features "Smart Current Detection" (SCD) that ensures device protection by adjusting the current/voltage required for each device. It will stop when your device is fully charged and will not overcharge.

- **Easy Access**

3 Cradles to hold your smart devices while charging and viewing 5. Vertical USB Charging Ports allow you to plug in your devices easily.

- **Speaker System**

Play and Charge Multiple Devices simultaneously.
Display, listen and view one device while charging others.

- **Organization**

The Tidy-Cable Organizer and 3 Cradle Holders eliminate the need to charge multiple devices in multiple locations. Hide and store excess cables and eliminate the clutter.

Note: Recognizes all smart devices (phones and tablets) of 5V from 0-2.1A.

Warnings and Precautions

WARNING: To reduce the risk of fire or electric shock, do not expose this unit to rain or moisture.

CAUTION: Use of controls or adjustments or performance of procedures other than those specified may result in hazardous radiation exposure.

“**Caution Marking and Rating Label**” is affixed under the lid or on the bottom of the unit with a mass not exceeding 7kg.

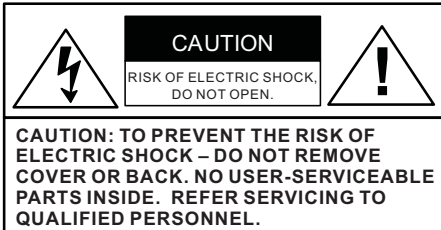

This symbol is intended to alert you to the presence of uninsulated, dangerous voltage within the unit's enclosure that might be of a sufficient magnitude to constitute a risk of electric shock. **DO NOT OPEN THE UNITS CASE.**



This symbol is intended to inform you that important operating and maintenance instructions are included in the literature accompanying this product.

SAFETY

For units with an insertable AC Power Adapter cordset:

- The power adapter should remain operable for its intended use. Disconnect the AC Power Adapter if you are not intending to use the unit for a long period of time.
- When connecting or disconnecting the AC Power Adapter Cord, grip the plug and not the cord itself. Pulling the cord may cause damage and create a hazard.

For units with a Rechargeable Battery:

- Do not expose batteries to excessive conditions – extreme cold, heat, sun or fire.

MOISTURE AND CONDENSATION

If the unit is exposed to moisture and extreme cold temperatures and moved to a warm environment, condensation may form on the units internal components. Under these circumstances, turning the power “ON” may cause damage to the unit or cause harm to the user. Allow the unit to stand in a warm environment for 1 to 3 hours and allow the unit to air dry safely.

WHEN IN USE

- Do not use this unit in conditions that are extreme – hot, cold, dusty or humid.
- Do not restrict the air flow of the unit by placing it on a soft surface like a bed, carpet or covering.

FCC INFORMATION

This unit complies with part 15 of the “FCC Rules.” Operation is subject to the following conditions:

1. This unit may not cause harmful interference.
2. This unit must accept any interference received, including interference that may cause undesirable operation.



Double insulation.
This is a Class II apparatus.



Intertek
3183565

Important Safety Instructions

1. Read These Instructions: All safety and operations manual should be read before the product is operated.

2. Keep These Instructions: The safety and operations manual should be retained for future reference.

3. Heed All Warnings: All warnings applicable to the unit and in the operations manual should be adhered to.

4. Follow All Instructions: All operations manual should be followed.

5. Water and Moisture: Do not use this unit near water. For example, do not use near a bath tub, wash bowl, kitchen sink, or laundry tub. Do not use this unit in a wet basement or near a swimming pool or similar location. The unit shall not be exposed to dripping or splashing and no objects filled with liquids (ex: vases), shall be placed on or near this unit.

6. Cleaning: Clean the unit only with a dry cloth. Unit must be unplugged from the wall outlet before cleaning. Do not use liquid cleaners or aerosol cleaners on the unit.

7. Ventilation: Slots and openings in the cabinet of the unit are provided to ensure reliable operation and ventilation and to protect the unit from overheating. The openings must not be covered and should never be blocked by placing the product on a soft surface like a bed, sofa, or rug. This unit should not be placed in a built-in installation like a bookcase or rack, unless proper ventilation is provided.

8. Heat: Do not install the unit near any heat source like a radiator, heat register, stove or other device that produces heat, including amplifiers.

9. Grounding or Polarization: If applicable, do not disable or circumvent the polarized or grounding-type plug. A polarized plug has 2 blades with 1 wider than the other. A grounding-type plug has 2 blades and a 3rd grounding plug. The wide blade, or the 3rd prong, is provided for your safety. If the provided plug does not fit into an outlet, consult a qualified electrician for replacement of this outlet.

10. Power Cord Protection: Protect the power cord from being walked on, pinched or cut or damaged in any

way. If any damage occurs, consult with a trained technician for repair.

11. Accessories: Only use accessories specified and approved by the manufacturer. Do not place this unit on an unstable cart, stand, tripod, bracket or table that has not been previously approved by the manufacturer. This unit may fall, causing serious injury to a child, adult or to the unit itself. Any mounting of the unit should be done within the manufacturer's guidelines.

12. Transporting: If a pre-approved device is used to transport this unit, caution and care must be observed and practiced to avoid damages. Make sure the device and unit together are stable before moving.



S3125A

PORTABLE
CART
WARNING

13. Lightning: Unplug this unit and disconnect the antenna or cable system during lightning storms or when unused for long periods of time. This will help prevent damage to the unit due to lightning and power line surges.

14. Servicing: Do not attempt to service this unit yourself. Opening or removing covers may expose you to dangerous voltage or other hazards. Refer all servicing to a qualified service technician.

15. Power Sources: Only connect to the type of household power supply as indicated in the operations manual and "Caution Marking and Rating Label." If you are not sure of the type of power supplied to your home (or location of the outlet the unit is being plugged into), consult with the local power company. For units intended to operate from battery power, or other sources, refer to the manufacturer's operations manual.

16. Overloading: Do not overload wall outlets or extension cords. This can result in a risk of fire or electric shock and may be hazardous.

17. Foreign Material: Protect this unit from intrusion of any foreign substances like dirt, water, moisture and insects. Do not force any foreign materials or chemicals into this unit. This could result in a risk of fire or electric shock and may be hazardous.

18. Replacement Parts and Safety Check: When replacement parts are required, be sure the service technician has used replacement parts specified and approved by the manufacturer. Ask the service technician to perform safety checks to ensure the proper operation to avoid possible fire, electric shock or other hazards.

19. Outdoor Antenna Grounding: If an outside antenna or cable system is connected to the unit, be sure the antenna or cable system is grounded to provide some protection against voltage surges and built-up static charges. If there is any doubt to the proper grounding of these systems, contact a qualified electrician to inspect your location.

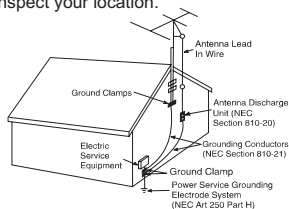

20. Wall or Ceiling Mounted: The unit should be mounted to a wall or a ceiling only as recommended by the manufacturer.

21. Disconnect Device: Make sure all disconnect devices are in proper working condition and readily available in the event of an emergency or if power "off" is needed quickly.

22. Protective Attachment Plug: If applicable, this unit may be equipped with an attachment plug having overload protection. This is a safety feature. See the operations manual for replacement or resetting of this protective device. If replacement of the plug is required, be sure the qualified service technician has used a replacement plug specified by the manufacturer that has the same overload protection as the original plug.

23. Power Lines: An outside antenna system should not be located in the vicinity of overhead power lines or other electric light or power circuits, or where it can fall into such power lines or circuits. When installing an outside antenna system, extreme care should be taken to keep from touching such power lines or circuits, as contact with them may be fatal. Always consult with your local power company before installing an outside antenna.

Quick Start On Charging Your Device

Remove Items From Package

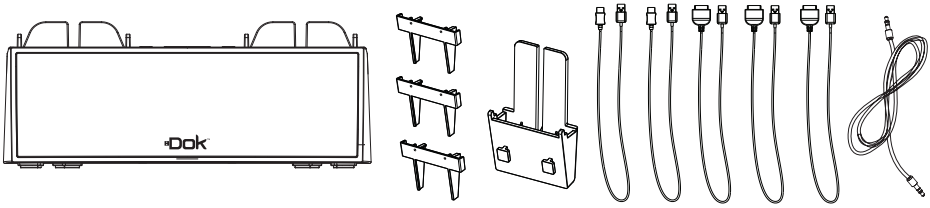

Connect Unit to Power Outlet

Plug the included AC power cord into an AC power outlet to power the unit. Press the  button to power ON/OFF.

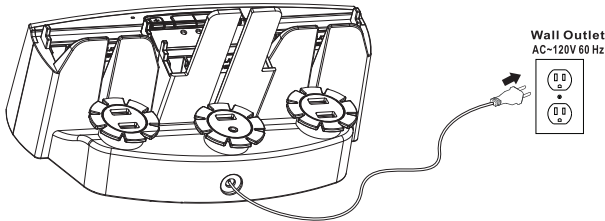

How to Charge Your Devices

1. Connect the charging cable to your device:

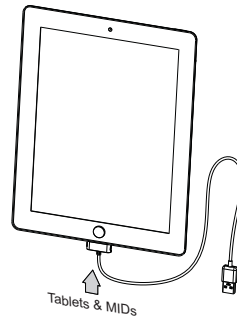
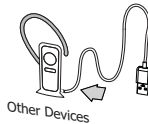
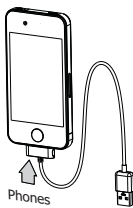

If necessary, disconnect your USB cable from your existing smart phone power adaptor, then use the charging cable that comes with your phone.

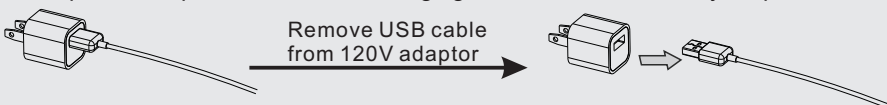

NOTE: Older model phones may not come with a USB charging cable. Contact your phone's service provider or review the cables available in this catalog.

Quick Start On Charging Your Device

2. Connect your device to 1 of the 5 USB Charging Ports, as per below:

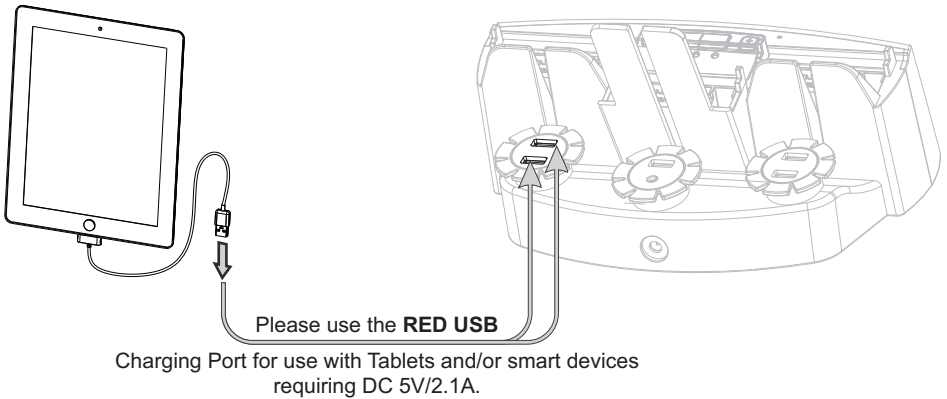
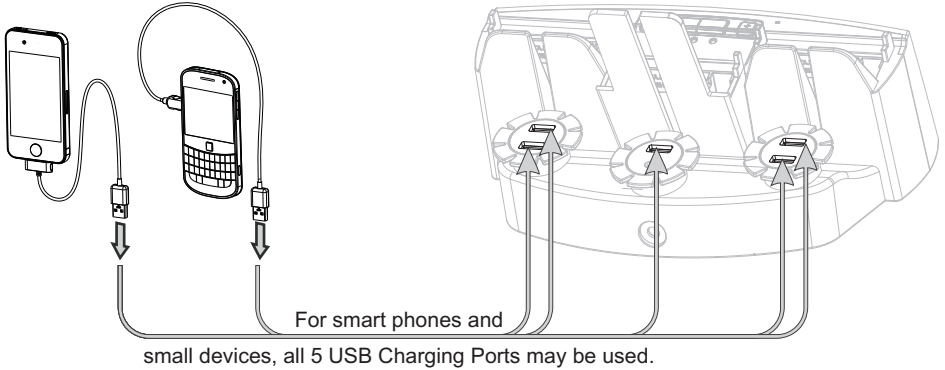

PLEASE NOTE:

- A. The **RED USB** Charging Port provides a maximum of 2.1A charging current designated to charge most 5V smart devices. It could take longer to fully charge smart devices that exceed 2.1A.
- B. Even in the OFF mode, as long as an active power is connected to the unit, your smart device can be charged still.

3. Wrap your cord to the Tidy-Cable Organizer:

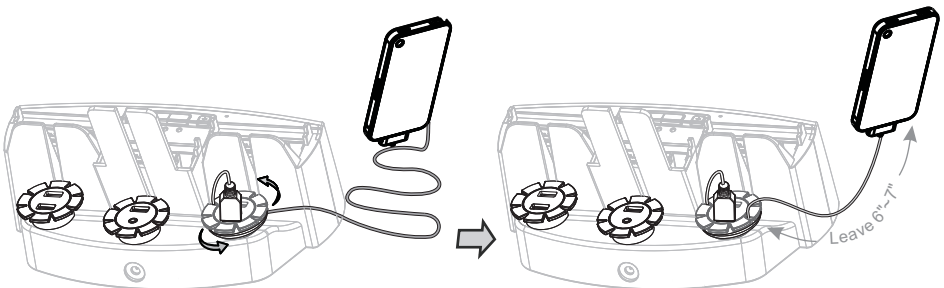

Quick Start On Charging Your Device

4. Your smart device's shape will determine if an insert is needed. Use the insert for flat-bottom phones. Round-bottom phones do not need the insert;

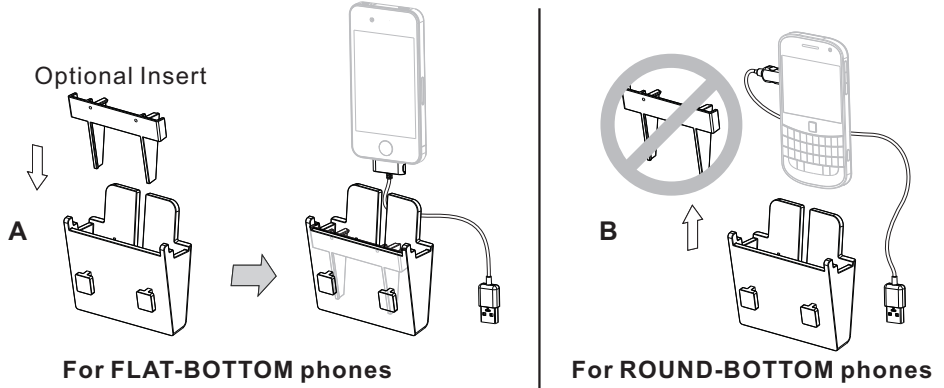

5. Wrap excess cable around cable organizer leaving enough cable to allow phone to be inserted into cradle;

a. For flat-bottom phones;

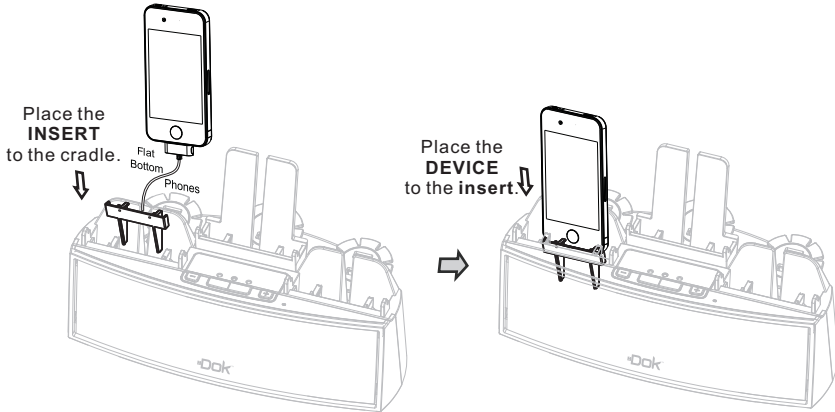

b. For round-bottom phones, remove the insert.

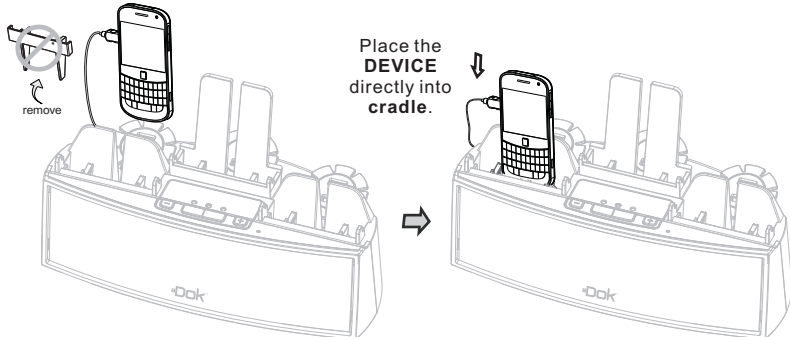

Quick Start On Charging Your Device

c. For TABLETS & MIDs;

- USE WITH FIXED CRADLES: Insert Charging Cable and place smart device to the 2 FIXED cradles (Vertically or Horizontally).

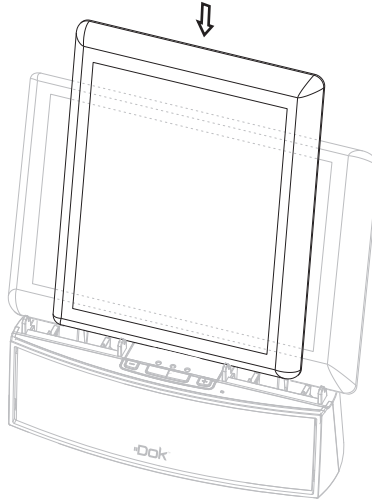

- USE WITH DETACHABLE CRADLE (included):

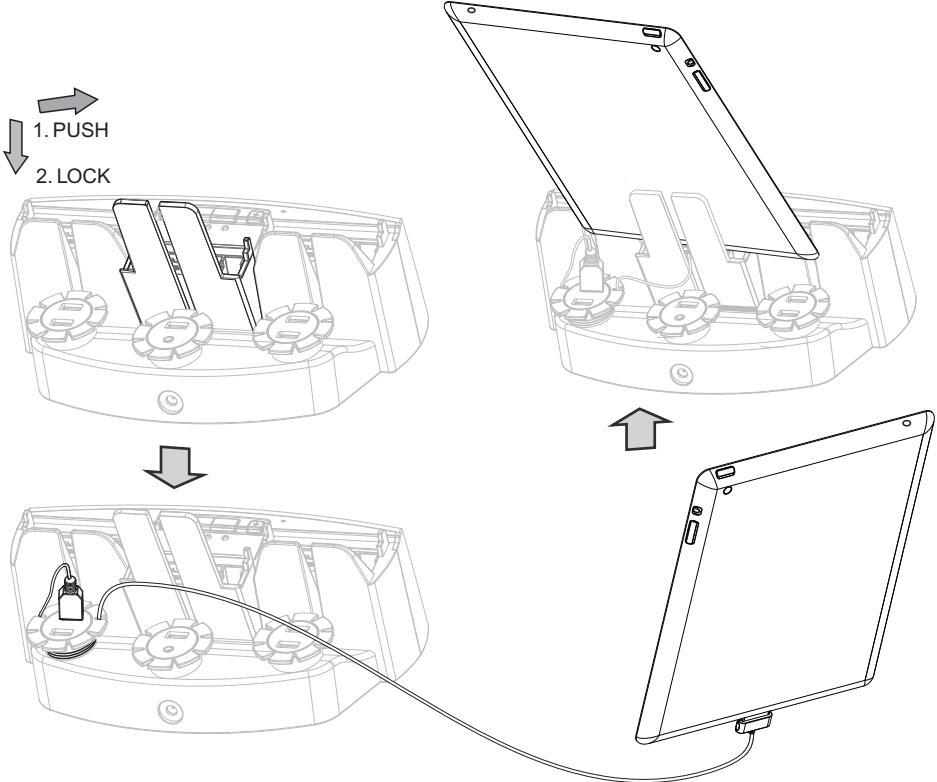

Quick Start On Charging Your Device

6. Disconnect the smart device from the USB Charging Cable and leave Charging Cable plugged into the Charging Station for easy re-connection.

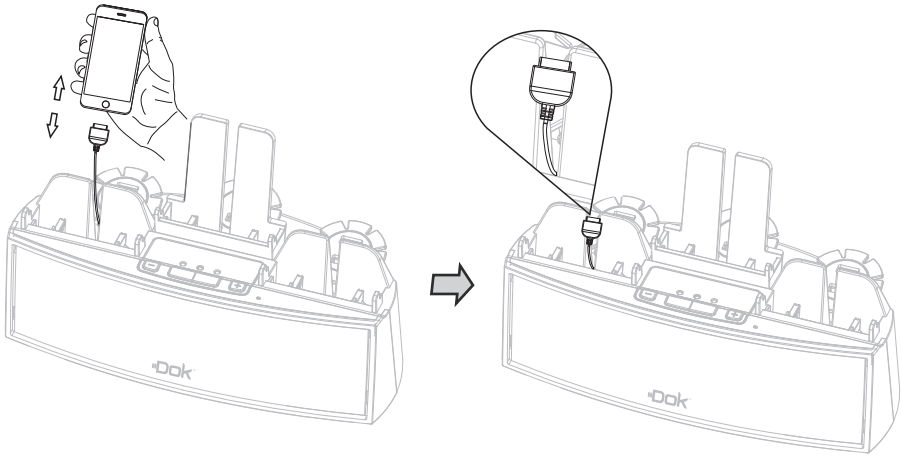

What's in the Gift Box



CR33 Base Unit



1 Device Cradle &
3 Cradle Inserts



Speaker (AUX IN) Cable



USB Phone Charging Cables



User's Manual

Location of Functions

Front View

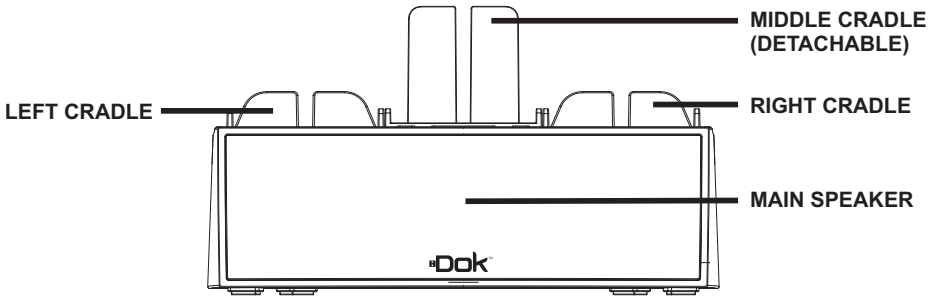

Top View

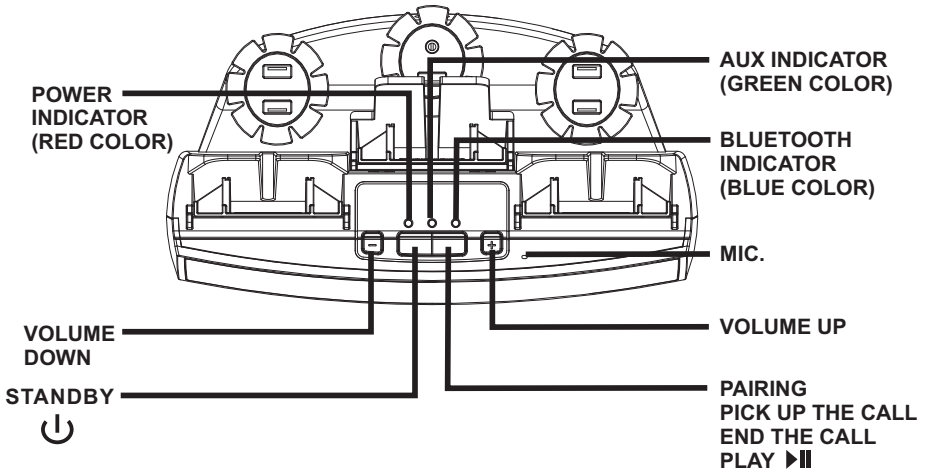

Rear View

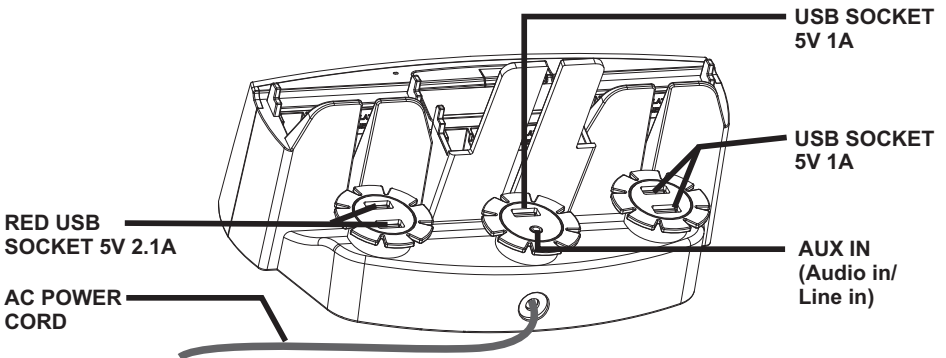

Operation

► Charging Your Smart Phone or Other Personal Devices:

- Cradle and hold up to 3 smart devices.
- Charge and view up to 5 smart devices simultaneously with 5 Vertical USB Charging Ports.

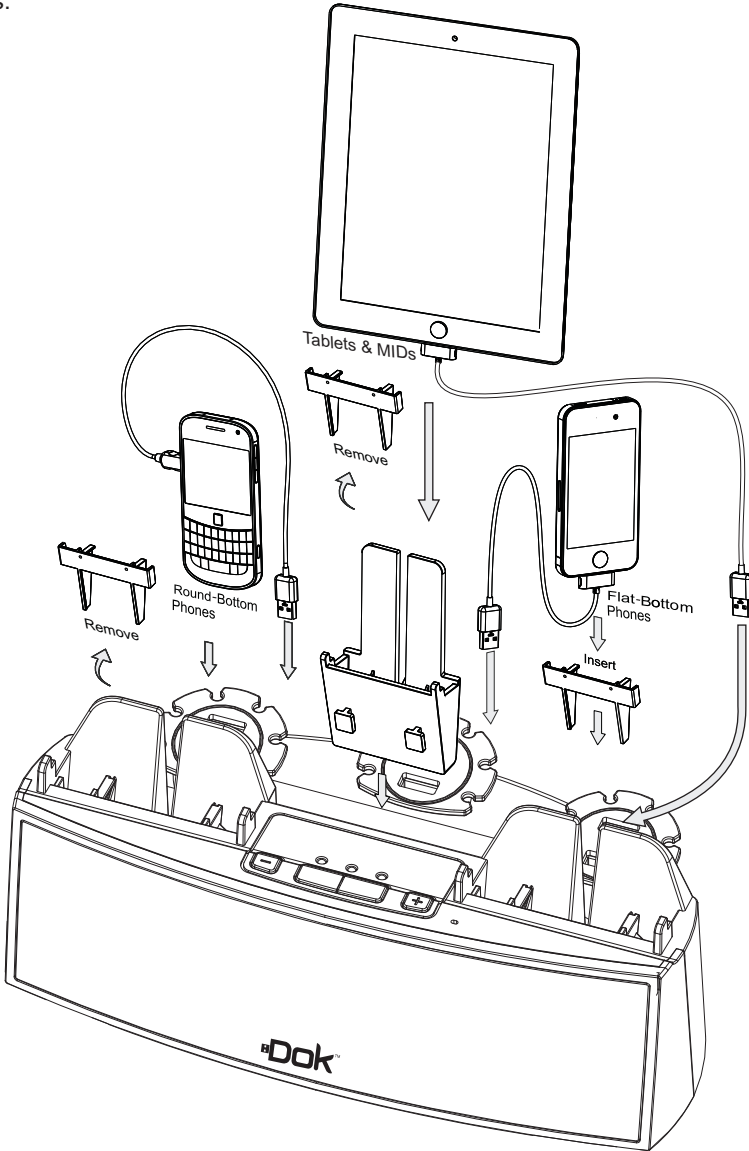

Your smart device will determine if an **INSERT** is needed. Use the **INSERT** for Flat-Bottom devices. Round-Bottom devices **do not require** an **INSERT**.

Operation (continued)

► Setting Up Your Smart Devices

1. Push the end of USB cord into a slot:

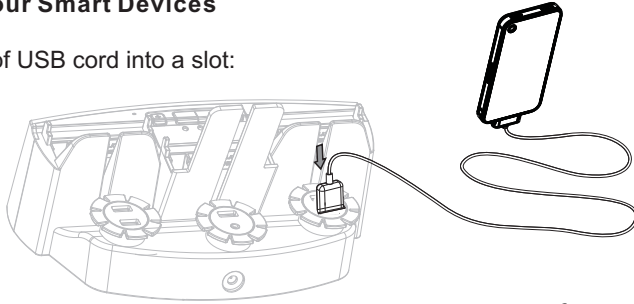

2. Wrap the USB cord around the Tidy Cable Organizer:

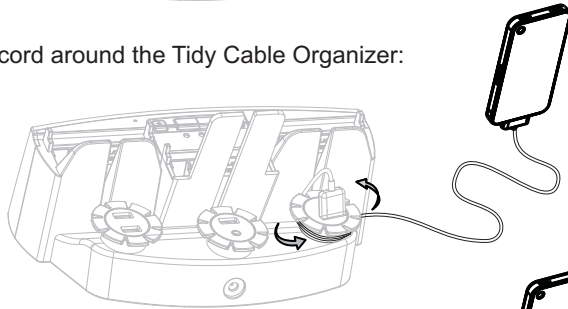

3. Leave an ample amount of cord to cradle and plug into your smart device:

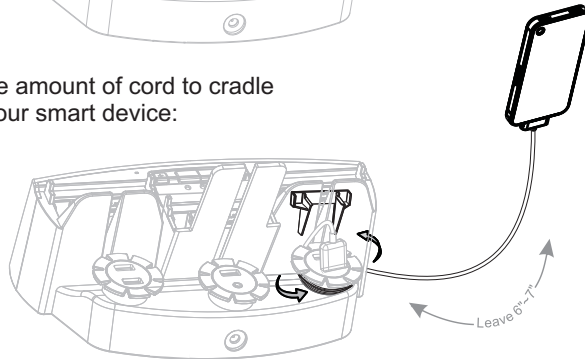

4. Place smart device into the desired cradle location:

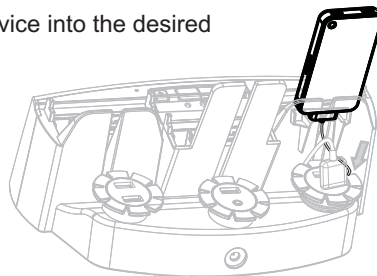

PLEASE NOTE:

- A. The **RED** USB Charging Port provides a maximum of 2.1A charging current designated to charge most 5V smart devices. It could take longer to fully charge smart devices that exceed 2.1A.
- B. Even in the OFF mode, as long as an active power is connected to the unit, your smart device can be charged still.

Operation (continued)

► Using Bluetooth

STEP 1 - Pairing Your Smart Phone Using Bluetooth:

- A. Power the unit "On" by pressing the  button.
- B. Bluetooth Indicator Light Flashes.





STEP 2 - Setting your smart device to "Discover" the Unit:

- A. Activate the Bluetooth Technology on your smart device.
- B. Select "Setup", "Connect" or the "Bluetooth" Menu on your Smart Phone.
- C. Select the option to "Discover" or "Add" a Bluetooth device.



STEP 3 - Using Your Smart Device to Connect to the Unit:



- A. The Smart Device will "Discover" the Model #.
- B. The Smart Device will ask if you want to pair with the Model #.
- C. Select "Yes" or "OK" to accept the pairing and your Smart Device will confirm when complete.
- D. If they are paired, the Bluetooth Indicator light will be constant.
- E. If they are not paired, the Bluetooth Indicator light will flash.
- F. Repeat "Step 1" above or hold the  Button until they are paired.

STEP 4 - Playing Audio Via Bluetooth After Pairing:

- A. Press the   Button to "Play" or "Pause" the Audio Files from your Smart Device.
- B. To select music, search the "Music Center" or "Media Player" on your smart device.
- C. Press the "Play" button on your Smart Device to start music playing.
- D. Adjust volume to maximum on your Smart Device.
- E. Control volume using the +/- buttons on the Unit.
- F. Music will "Pause" automatically when your Smart Device receives a telephone call. Music will resume when call is ended.

STEP 5 - Music and Settings are controlled by and through the Unit.



STEP 6 - You can automatically make a telephone call with Bluetooth after the pairing by pressing the   Buttons to answer the call and speaking into MIC area.

STEP 7 - Answer or end a telephone call using Bluetooth by pressing the   Button.

Operation (continued)

► Using the Audio Input/Line Input (AUX-In) Jack Cable (included):

You can play your portable audio device and/or smart device with a standard 3.5mm headphone jack audio patch cord/speaker cable using the AUX-In Jack.

1. Plug one end of a standard Aux-In cord into the Aux-Out/Headphone Jack of your device and the other end into the unit's Aux-In Jack, located on the back of the unit.
2. Press the  button to turn the unit on.
3. Turn on and play the personal/smart device.
4. Press and release the **+** or **-** to adjust the system volume. You may need to adjust the volume on your external device as well;
5. Press the  again to turn the unit off. Your personal/smart device will continue playing until you use the device's controls to stop.
6. You can answer the phone while AUX IN is plugged in. The caller's voice will come through the speaker. When the caller hang ups, your music will be automatically resumed.

WARNING: When the AUX IN Speaker Cable is plugged into the Unit, the Bluetooth feature will not work.

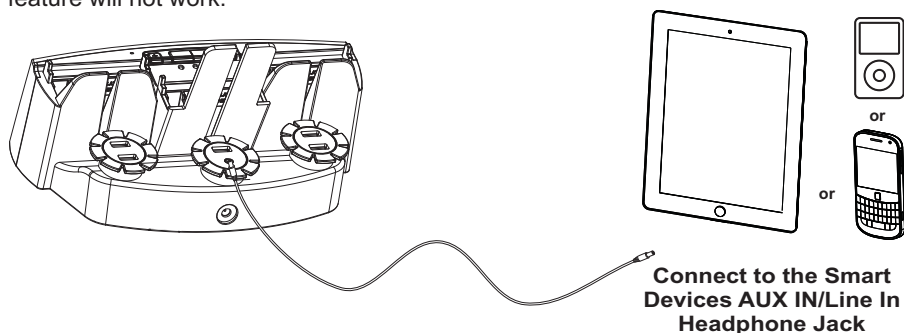

Troubleshooting

SYMPTOM	POSSIBLE PROBLEM	SOLUTION
Unit does not turn on:	Power cord does not plug into the wall socket.	Plug the power cord into a working wall socket.
No sound:	Power cord disconnected or loose.	Check the connection or the power cord.
	Bluetooth not paired or disconnected.	Pair the Bluetooth.
	AUX IN cable disconnected or loose.	Check the connection.
	Listen the Bluetooth but AUX IN cable is connected.	Disconnect the AUX IN cord.
	Your personal/smart device volume setting is too low.	Turn up the volume on your personal/smart device.
Can not get paired with Bluetooth:	AUX IN cable is connected.	Unplugged the AUX IN cord from the unit.
Sound is distorted:	Volume level is set too high.	Decrease the volume on your personal/smart device.
	Sound source is distorted.	If the personal/smart device sound source is old or of poor quality, distortion and noise are easily noticed with high-power speakers. Try a different audio file from a trusted source.
Tablet/MID's/ Smart Device won't charge:	You may have plugged into the wrong USB Charging ports (5V/1.1A-white).	Plug the device into the RED USB Charging Port. Only the RED port provides the necessary 5V/2.1A power for most tablets or smart devices.

ORDER FORM

ACCESSORY USB CHARGING CORDS

USB charging cords for pre-Smart Phone generations



AP Devices
Price: \$5.00
Sku: UCAP
Buy Now



Samsung/Tablet
Price: \$5.00
Sku: UC800
Buy Now



Mini USB
Price: \$5.00
Sku: UCMV3
Buy Now

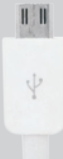

Micro USB
Price: \$5.00
Sku: UCMV8
Buy Now

Make Checks or Money Orders Payable to: DOK Solution, LLC. Add \$3.00 S&H.

PLEASE PRINT CLEARLY

Name: _____

Address: _____

City: _____ State: _____ Zip: _____

Phone: _____

Email: _____

Brand of Phone: _____ Model No.: _____

Visa MasterCard Discover AMEX

CC# _____

Exp Date: _____ / _____ CVV _____ Signature: _____

